

MeetingEye 500 Pro

Package Contents

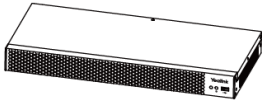

MeetingEye 500 Pro Codec

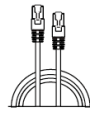

(3.0m, 9.84ft)

Ethernet Cable

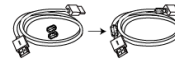

(1.8m, 5.91ft)

HDMI Cablex2



(1.8m, 5.91ft)

Power Adapter

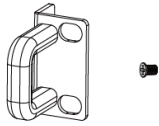

Mounting Ear x2, Screw x8



VCR11 Remote Control



Cable Tie x5

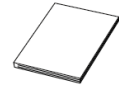

Quick Start Guide

⚠ WARNING

This is a Class A product. In a living environment, the product may cause radio interference. In this case, it may be necessary for the user to take practical measures against the interference.

Optional Accessories

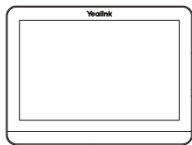

CTP18



VCH51

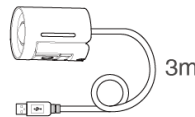

UVC30-Room

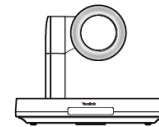

UVC84

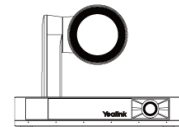

UVC86

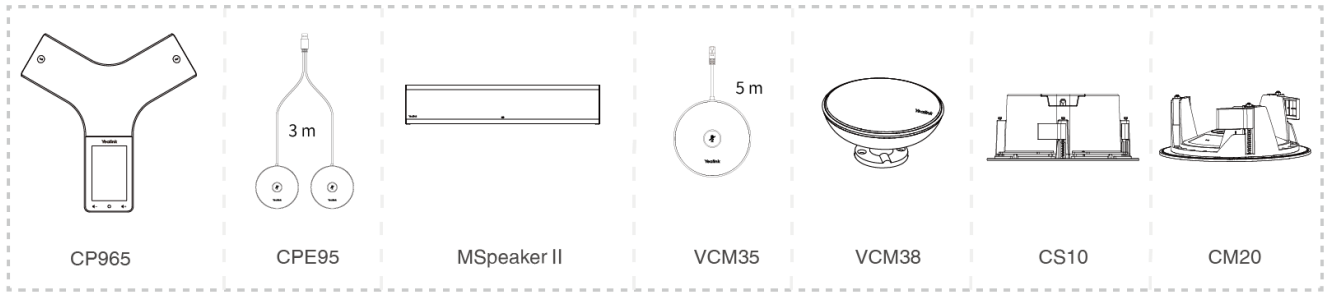

Installation

Put on the Desk

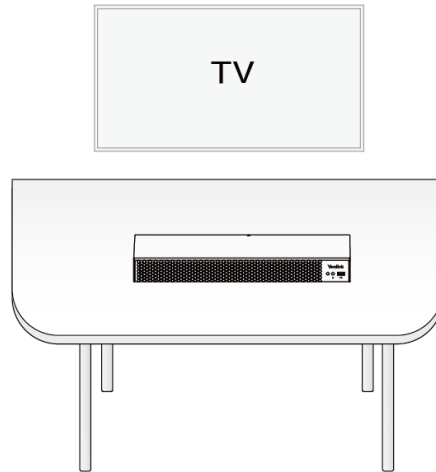

Mount in a Rack

NOTE

The rack in which the MeetingEye 500 Pro will be placed must be a 19-inch Rack compliant with IEC 60297.

1. Install the mounting ears to the sides of the MeetingEye 500 Pro.

NOTE

Tighten the ear lock, we recommend that locking torque is greater than 6kgf.cm.

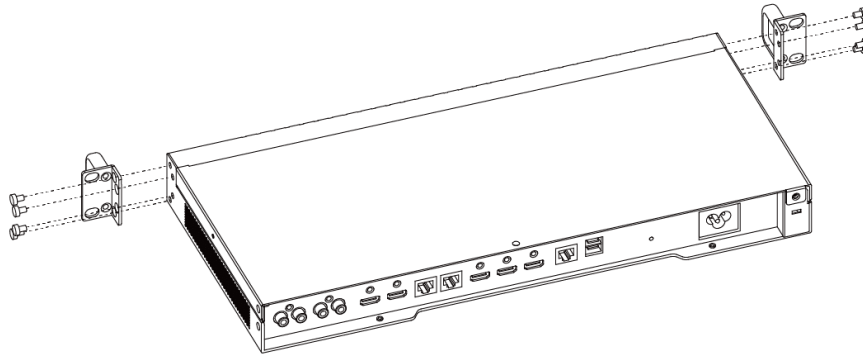

2. Push the MeetingEye 500 Pro into the rack, and then fix it to the rack with screws.

NOTE

Package Contents do not include standard rack screws.

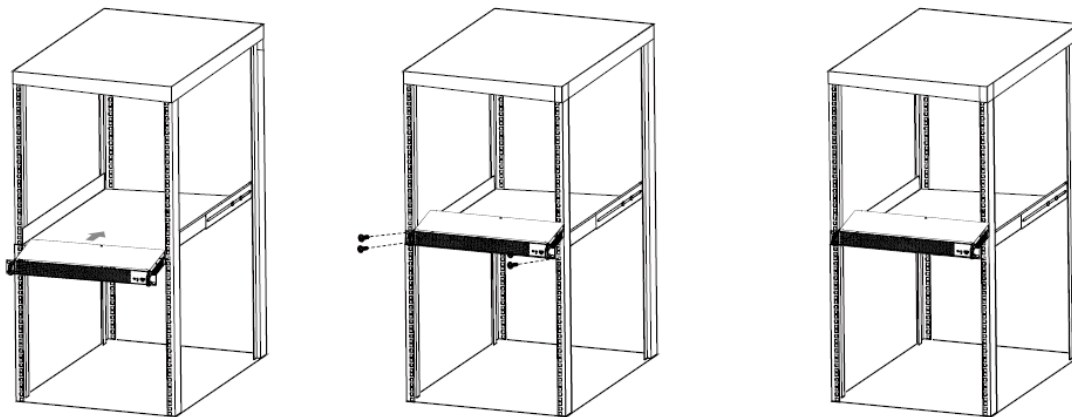

Connections

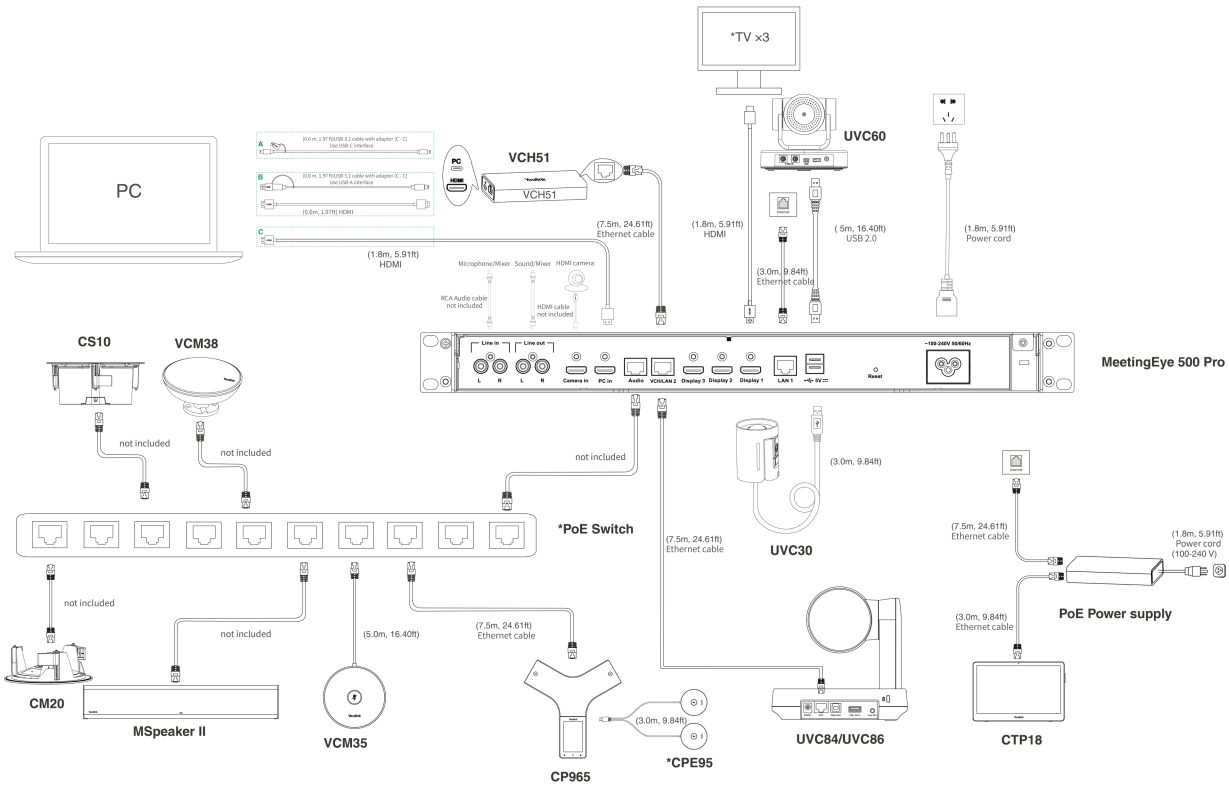

NOTE

- Use the Yealink original power adapter (~100-240V 50/60Hz) to charge the endpoint only. The use of the third-party power adapter may cause the damage. If you find any cable damage during use, please replace it immediately.
- When connecting a PoE switch to a Yealink CM20 or CS10, the switch needs to disable the EEE (Energy Efficient Ethernet) feature.
- CPE95 only supports use with CP965.

Supported Accessories

For the compatible devices and the maximum number of compatible devices, please refer to [Zoom Rooms Accessories Compatibility Lists](#).